

64M X 64 Bit (512MB) 184-Pin Unbuffered DDR DIMM (PC2100) 1 Rank x 8

FEATURES

- PC2100 Compliant
Option D: DDR266A 133MHz-7.5ns; CL-tRCD-tRP = 2-3-3 clks
Option E: DDR266B 133MHz-7.5ns; CL-tRCD-tRP = 2.5-3-3 clks
- 184-Pin UDIMM form factor
- Auto and self refresh capability (8192 cycles/64ms refresh)
- SSTL_2 compatible inputs and outputs
- +2.5V ± 0.2V VDD and VDDQ
- DDR architecture: Two data accesses per clock cycle, differential clock inputs (CK0 and /CK0), and bi-directional data strobe (DQS)
- Four internal banks for concurrent operation
- Auto Precharge option for each burst access
- Burst lengths: 2, 4, 8
- All inputs are sampled at the positive going edge of the system clock; data referenced to both edges of DQS
- Serial Presence Detect with EEPROM
- RoHS Compliant, lead-free version available
- Commercial and Industrial Operating Temperature ranges available

GENERAL DESCRIPTION

The SL64C8M64M8L-B75xW(W)(U) is a 64M x 64 bit (512MB) Double Data Rate (DDR) Synchronous Dynamic RAM (SDRAM) Unbuffered Dual In-line Memory Module (UDIMM).

The module consists of eight CMOS 16M x 8 bit x 4 bank DDR SDRAMs in 66-pin 400-mil TSOP-II packages mounted on a 184-pin glass epoxy substrate. The DDR SDRAMs are organized in 1 rank.

A serial EEPROM using the two pin IIC protocol is mounted to provide for the Serial Presence Detects (SPD). Decoupling capacitors are mounted in parallel across the power supply. Damping resistors are added in series on the DQ, DM, and DQS signals.

The module has gold edge connections and is intended for mounting into 184-pin UDIMM edge connector sockets keyed for 2.5V VDD and VDDQ.

ORDERING INFORMATION

Part Number	CL	MHz	Bandwidth
SL64C8M64M8L-B75DW(W)(U)	2	133	2.1 GB/s
SL64C8M64M8L-B75EW(W)(U)	2.5	133	2.1 GB/s

Notes:

1. The Operating Temperature Range is selected as follows:
Commercial (0 to 70°C): no additional designator in the part number; *Industrial (-40 to 85°C):* the second "W" is added to the part number.
2. The "U" suffix added to the part number selects the RoHS Compliant, lead-free module.

PACKAGE DIMENSIONS

Units are in inches (millimeters). Tolerances are ±0.005 (±0.127) unless otherwise specified.

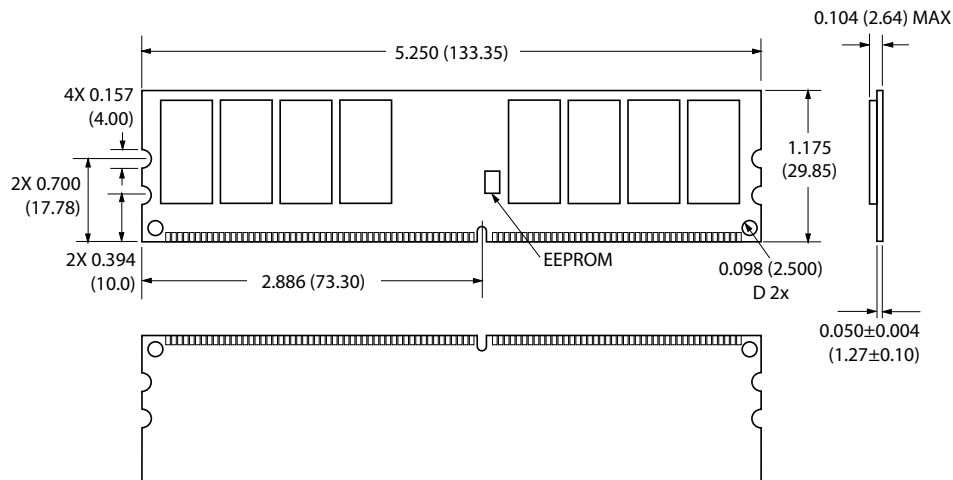

Detail: Notch and Pad

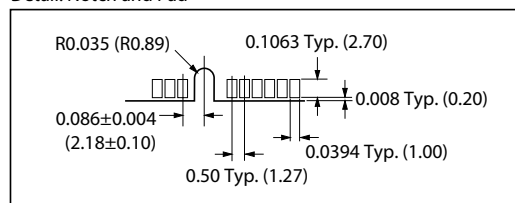

(Where second W selects Industrial Operating Temperature; U selects RoHS Compliant, lead-free version.)

PIN CONFIGURATION (* = Not Used; / = Active Low)

Pinout

Pin	Front	Pin	Back	Pin	Front	Pin	Back	Pin	Front	Pin	Back
1	VREF	93	VSS	32	A5	124	VSS	62	VDDQ	154	/RAS
2	DQ0	94	DQ4	33	DQ24	125	A6	63	WE	155	DQ45
3	VSS	95	DQ5	34	VSS	126	DQ28	64	DQ41	156	VDDQ
4	DQ1	96	VDDQ	35	DQ25	127	DQ29	65	/CAS	157	/S0
5	DQS0	97	DM0	36	DQS3	128	VDDQ	66	VSS	158	/S1*
6	DQ2	98	DQ6	37	A4	129	DM3	67	DQS5	159	DM5
7	VDD	99	DQ7	38	VDD	130	A3	68	DQ42	160	VSS
8	DQ3	100	VSS	39	DQ26	131	DQ30	69	DQ43	161	DQ46
9	NC	101	NC	40	DQ27	132	VSS	70	VDD	162	DQ47
10	/RESET*	102	NC	41	A2	133	DQ31	71	/S2*	163	/S3*
11	VSS	103	FETEN*	42	VSS	134	CB4*	72	DQ48	164	VDDQ
12	DQ8	104	VDDQ	43	A1	135	CB5*	73	DQ49	165	DQ52
13	DQ9	105	DQ12	44	CB0*	136	VDDQ	74	VSS	166	DQS3
14	DQS1	106	DQ13	45	CB1*	137	CK0	75	CK2	167	A13*
15	VDDQ	107	DM1	46	VDD	138	/CK0	76	/CK2	168	VDD
16	CK1	108	VDD	47	DQS8*	139	VSS	77	VDDQ	169	DM6
17	/CK1	109	DQ14	48	A0	140	DM8*	78	DQS6	170	DQ54
18	VSS	110	DQ15	49	CB2*	141	A10	79	DQ50	171	DQ55
19	DQ10	111	CKE1*	50	VSS	142	CB6*	80	DQ51	172	VDDQ
20	DQ11	112	VDDQ	51	CB3*	143	VDDQ	81	VSS	173	NC
21	CKE0	113	BA2*	52	BA1	144	CB7*	82	VDDID	174	DQ60
22	VDDQ	114	DQ20		Key		Key	83	DQ56	175	DQ61
23	DQ16	115	A12	53	DQ32	145	VSS	84	DQ57	176	VSS
24	DQ17	116	VSS	54	VDDQ	146	DQ36	85	VDD	177	DM7
25	DQS2	117	DQ21	55	DQ33	147	DQ37	86	DQS7	178	DQ62
26	VSS	118	A11	56	DQS4	148	VDD	87	DQ58	179	DQ63
27	A9	119	DM2	57	DQ34	149	DM4	88	DQ59	180	VDDQ
28	DQ18	120	VDD	58	VSS	150	DQ38	89	VSS	181	SA0
29	A7	121	DQ22	59	BA0	151	DQ39	90	NC	182	SA1
30	VDDQ	122	A8	60	DQ35	152	VSS	91	SDA	183	SA2
31	DQ19	123	DQ23	61	DQ40	153	DQ44	92	SCL	184	VDDSPD

Pin Description

Pin Symbol	Pin Description
A0-A11, A12, A13*	SDRAM address bus
BA0-BA1, BA2*	SDRAM bank select
DQ0-DQ63	DIMM memory data bus
CB0*-CB7*	DIMM ECC check bits
/RAS	SDRAM row address strobe
/CAS	SDRAM column address strobe
WE	SDRAM write strobe
/S0, /S1*, /S2*, /S3*	SDRAM chip select lines (physical ranks 0, 1, 2, and 3)
CKE0, CKE1*	SDRAM clock enable lines
DQS0-DQS7, DQS8*	SDRAM data strobes
DM0-DM7, DM8*	SDRAM data mask
CK0, CK1, CK2	SDRAM clock (positive line of differential pair)
/CK0, /CK1, /CK2	SDRAM clock (negative line of differential pair)

Pin Symbol	Pin Description
SCL	IIC serial bus clock for EEPROM
SDA	IIC serial bus data line for EEPROM
SA0-SA2	IIC slave address select for EEPROM
VDD	SDRAM positive power supply
VDDQ	SDRAM I/O driver positive power supply
VDDID	VDD Identification flag (No connect for VDD=VDDQ)
VREF	SDRAM I/O reference supply
VSS	Power supply return (ground)
VDDSPD	Serial EEPROM positive power supply (2.2V to 5.5V)
NC	Spare pins (no connect)
/RESET*	Reset pin (forces register inputs low)
FETEN*	FET enable line

(Where second W selects Industrial Operating Temperature; U selects RoHS Compliant, lead-free version.)

FUNCTIONAL BLOCK DIAGRAM

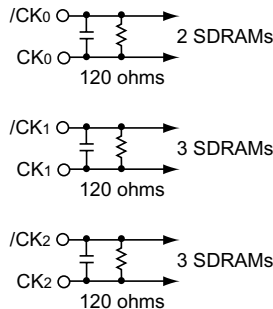
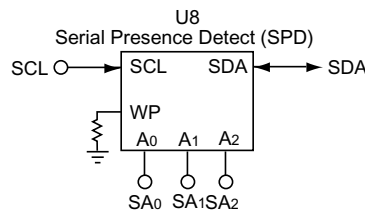
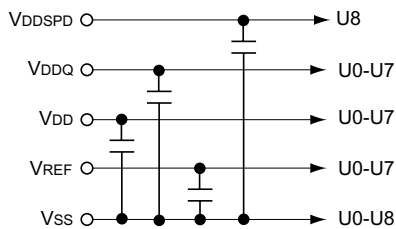
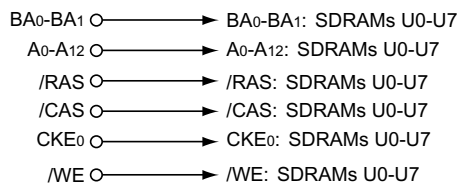
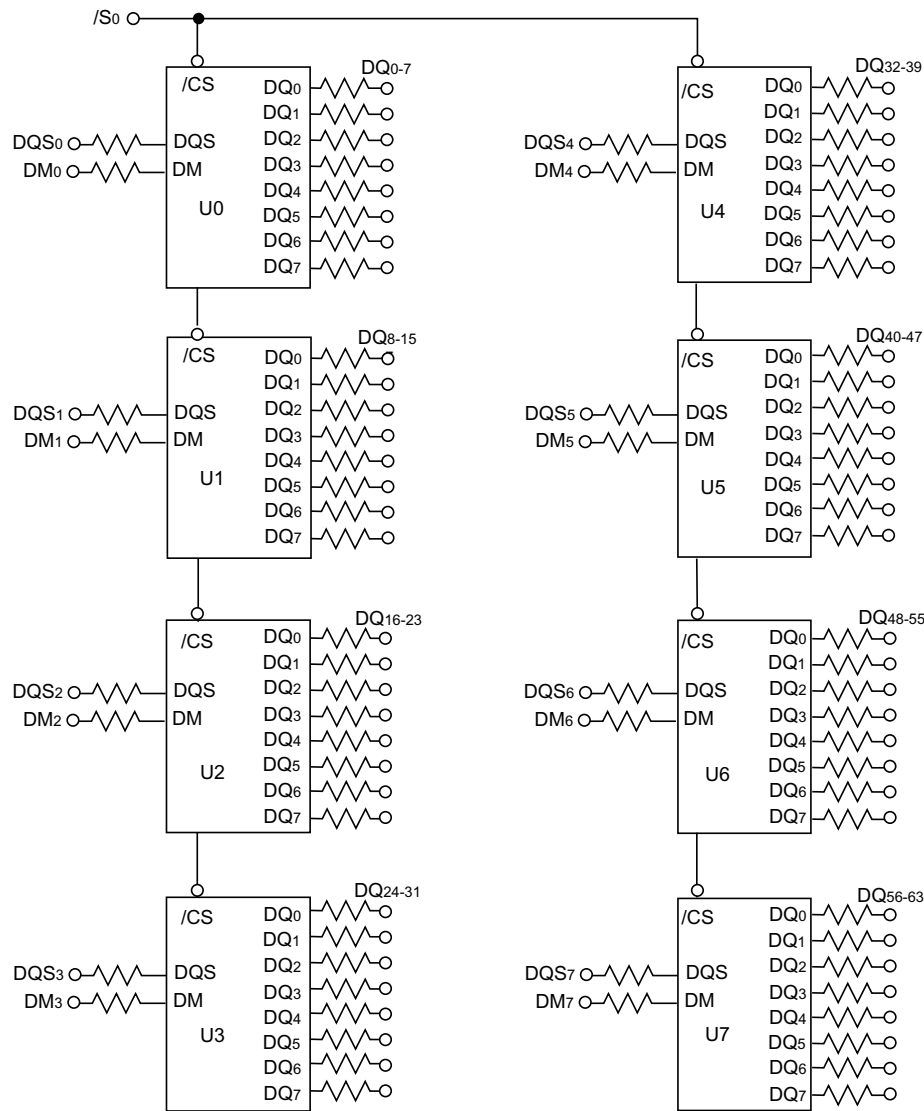

NOTES:

1. DQ wiring may be changed within a byte.
2. DQ, DQS, DM, CKE, /S relationships must be maintained as shown.
3. DQ, DQS, and DM resistors are 22 ohms.

SERIAL PRESENCE DETECT INFORMATION

Serial PD Interface Protocol: IIC; Current sink capability of SDA driver $\leq 3\text{mA}$; Maximum clock frequency: 100 KHz

Byte #	Function Described	Function Supported	Hex Value
0	# of bytes written into serial memory at module manufacturer	128 bytes	80h
1	Total # of bytes of SPD memory device	256Bytes (2K-bit)	08h
2	Fundamental memory type	DDR SDRAM	07h
3	# of row addresses on this assembly	13	0Dh
4	# of column addresses on this assembly	11	0Bh
5	# of physical ranks on this assembly	1 rank	01h
6	Data width of this assembly	64 bits	40h
7	...Data width of this assembly (continued)	—	00h
8	Voltage interface level of this assembly	SSTL 2.5V	04h
9	SDRAM cycle time at CL=2.5 (tCYC)	7.5ns	75h
10	SDRAM access time from clock at CL=2.5 (tAC)	0.75ns	75h
11	DIMM configuration type	non-ECC	00h
12	Refresh rate/type	7.8 μs , Self -refresh	82h
13	SDRAM width	8 bits	08h
14	Error Checking SDRAM data width	none	00h
15	Min. CLK delay for back-to-back rand. col. addr.	t _{CCD} =1 CLK	01h
16	SDRAM device attributes: burst lengths supported	2,4,8	0Eh
17	SDRAM device attributes: # of banks on SDRAM device	4 banks	04h
18	SDRAM device attributes: CAS latency	CAS latency = 2.0, 2.5	0Ch
19	SDRAM device attributes: CS latency	CS latency = 0	01h
20	SDRAM device attributes: Write latency	Write Latency = 1	02h
21	SDRAM module attributes	Differential clock	20h
22	SDRAM device attributes: general	V _{DD} ±0.2V	00h
23	Minimum clock cycle time at CL=2 (tCYC)	7.5ns (DDR266A) 10ns (DDR266B)	75h A0h
24	Max. data access time form clock at CL=2 (tAC)	0.75ns	75h
25	Minimum clock cycle time at CL=1.5 (tCYC)	N/A	00h
26	Max. data access time from clock at CL=1.5 (tAC)	N/A	00h
27	Minimum row precharge time (tRP)	20.0ns	50h
28	Minimum row active to row active delay (tRRD)	15.0ns	3Ch
29	Minumum RAS to CAS (tRCD)	20.0ns	50h
30	Minumum RAS pulse width (tRAS)	45ns	2Dh
31	Module bank density	512MB	80h
32	Min. command and address signal setup time (tAS)	0.9ns	90h
33	Min. command and address signal hold time (tAH)	0.9ns	90h
34	Min. data/data mask signal input setup time (tDS)	0.5ns	50h
35	Min. data/data mask signal input hold time (tDH)	0.5ns	50h

continued on the next page

*(Where second W selects Industrial Operating Temperature; U selects RoHS Compliant, lead-free version.)***SERIAL PRESENCE DETECT INFORMATION** (continued)

Byte #	Function Described	Function Supported	Hex Value
36-40	Reserved for VCSDRAM		00h
41	Row cycle time (trc)	65ns	41h
42	Auto refresh cycle time (trfc)	75ns	4Bh
43	Maximum SDRAM device cycle time (tCK_MAX)	12ns	30h
44	DQS-DQ skew (tDQSQ)	0.5ns	32h
45	SDRAM device data hold skew factor (tQHS)	0.75ns	75h
46	Reserved		00h
47	DDR DIMM height	No DIMM Height Available	00h
48-61	Reserved		00h
62	SPD revision	JEDEC Initial Release	00h
63	Checksum for bytes 0-62	JEDEC calculation	xxh
64	Manufacturer's JEDEC ID code per JEP-106E	Continuation code	7Fh
65	Man. JEDEC ID code (continued)	STEC's ID	A8h
66-71			00h
72	Manufacturing location	STEC USA	xxh
73-90	Manufacturer's part number		xxh
91	Revision code of PCB	RevA(01),RevB(02)	xxh
92			00h
93	Manufacturing date	Year (BCD)	yy
94		Calender Week (BCD)	w w
95	Assembly serial number	Tester number	ss
96		Serial number (bits 7-0)	ss
97		Serial number (bits 15-8)	ss
98		Serial number (bits 23-16)	ss
99-127	Manufacturer's specific data		xxh
128-255	Open for Customer Use	Undefined	00h

ABSOLUTE MAXIMUM RATINGS

Permanent device damage may occur if ABSOLUTE MAXIMUM RATINGS are exceeded. Functional Operation should be restricted to recommended operating condition. Exposure to higher than recommended voltage for extended periods of time may affect device reliability.

Parameter	Symbol	Value	Unit
Voltage on any pin relative to VSS	V _{IN} , V _{OUT}	-1.0 to +3.6	V
Voltage on VDD supply relative to VSS	V _{DD}	-1.0 to +3.6	V
Voltage on VDDQ supply relative to VSS	V _{DDQ}	-1.0 to 3.6	V
Storage temperature	T _{STG}	-55 to +125	°C
Power Dissipation	P _D	12	W
Short circuit current	I _{OS}	50	mA

POWER and DC OPERATING CONDITIONS (SSTL_2 IN/OUT)

Recommended operating conditions (Voltage referenced to V_{SS}=0V)

Parameter	Symbol	Min	Max	Unit	Notes
<i>Operating Temperature</i>					
Commercial (without part number designator)	T _A	0	70	°C	
Industrial (with added part number designator, 2nd "W")	T _A	-40	85	°C	
Supply Voltage (for device with a nominal V _{DD} of 2.5V)	V _{DD}	2.3	2.7	V	
I/O Supply voltage	V _{DDQ}	2.3	2.7	V	
I/O Reference voltage	V _{REF}	0.49*V _{DDQ}	0.51*V _{DDQ}	V	1
I/O Termination voltage (system)	V _{TT}	V _{REF} -0.04	V _{REF} +0.04	V	2
Input logic high voltage	V _{IH} (DC)	V _{REF} +0.15	V _{DDQ} +0.3	V	4
Input logic low voltage	V _{IL} (DC)	-0.3	V _{REF} -0.15	V	4
Input voltage level, CK and /CK	V _{IN} (DC)	-0.3	V _{DDQ} +0.3	V	
Input differential voltage, CK and /CK	V _{ID} (DC)	0.36	V _{DDQ} +0.6	V	3
<i>Input leakage current</i>					
A, BA, /RAS, /CAS, /WE	I _L	-16	16	μA	
CKE, /S	I _L	-16	16	μA	
CK0, /CK0	I _L	-4	4	μA	
CK1-2, /CK1-2	I _L	-6	6	μA	
DM	I _L	-2	2	μA	
Output leakage current: DQ, CB, DQS	I _{OZ}	-5	5	μA	
Output high current (V _{OUT} = V _{DDQ} - 0.373V, minimum V _{REF} , minimum V _{TT})	I _{OH}	-16.8		mA	
Output low current (V _{OUT} = 0.373V, maximum V _{REF} , maximum V _{TT})	I _{OL}	16.8		mA	

- Includes ± 25mV margin for DC offset on V_{REF}, and a combined total of ± 50mV margin for all AC noise and DC offset on V_{REF}, bandwidth limited to 20MHz. The DRAM must accommodate DRAM current spikes on V_{REF} and internal DRAM noise coupled to V_{REF}, both of which may result in V_{REF} noise. V_{REF} should be de-coupled with an inductance of ≤ 3nH.
- V_{TT} is not applied directly to the device. V_{TT} is a system supply for signal termination resistors, is expected to be set equal to V_{REF}, and must track variations in the DC level of V_{REF}
- V_{ID} is the magnitude of the difference between the input level on CK and the input level on /CK.
- These parameters should be tested at the pin on actual components and may be checked at either the pin or the pad in simulation. The AC and DC input specifications are relative to a V_{REF} envelop that has been bandwidth limited to 200MHZ.
- The value of V_{IH} is expected to equal 0.5*V_{DDQ} of the transmitting device and must track variations in the dc level of the same.
- These characteristics obey the SSTL-2 class II standards.

(Where second W selects Industrial Operating Temperature; U selects RoHS Compliant, lead-free version.)

DC CHARACTERISTICS

(Recommended operating conditions unless otherwise noted. Module IDD was calculated on the basis of component IDD and can be differently measured according to DQ loading cap. VDD=2.7V. T_A=10°C)

Parameter/Condition	Symbol	Max	Units
OPERATING CURRENT: One bank; Active-Precharge; t RC = t RC (MIN); t CK = t CK (MIN); DQ, DM and DQS inputs changing once per clock cycle; Address and control inputs changing once every two clock cycles;	IDD0*	920	mA
OPERATING CURRENT: One bank; Active-Read-Precharge; Burst = 4; t RC = t RC (MIN); t CK = t CK (MIN); IOU _T = 0mA; Address and control inputs changing once per clock cycle	IDD1*	1,160	mA
PRECHARGE POWER-DOWN STANDBY CURRENT: All banks idle; Power-down mode; t CK = t CK (MIN); CKE = (LOW)	IDD2P**	40	mA
IDLE STANDBY CURRENT: /CS = HIGH; All banks idle; t CK = t CK MIN; CKE = HIGH; Address and other control inputs changing once per clock cycle. VIN = VREF for DQ, DQS, and DM	IDD2F**	320	mA
ACTIVE POWER-DOWN STANDBY CURRENT: One bank active; Power-down mode; t CK = t CK (MIN); CKE = LOW	IDD3P**	240	mA
ACTIVE STANDBY CURRENT: /CS = HIGH; CKE = HIGH; One bank; Active-Precharge; t RC = t RAS (MAX); t CK = t CK (MIN); DQ, DM and DQS inputs changing twice per clock cycle; Address and other control inputs changing once per clock cycle	IDD3N**	360	mA
OPERATING CURRENT: Burst = 2; Reads; Continuous burst; One bank active; Address and control inputs changing once per clock cycle; t CK = t CK (MIN); IOU _T = 0mA	IDD4R*	1,160	mA
OPERATING CURRENT: Burst = 2; Writes; Continuous burst; One bank active; Address and control inputs changing once per clock cycle; t CK = t CK (MIN); DQ, DM, and DQS inputs changing twice per clock cycle	IDD4W*	1,080	mA
AUTO REFRESH CURRENT: t RC = t RC(MIN)	IDD5*	2,240	mA
SELF REFRESH CURRENT: CKE <= 0.2V	IDD6**	40	mA
OPERATING CURRENT: Four bank interleaving READs (BL=4) with auto precharge, t RC = t RC (MIN); t CK = t CK (MIN); Address and control inputs change only during Active READ, or WRITE commands.	IDD7*	2,800	mA
<p>* In a module with more than one rank, IDD_n is calculated with one rank in IDD_n and the other ranks in IDD2P.</p> <p>** All ranks in IDD_n.</p> <p>where n=corresponding IDD condition listed in Symbol column.</p> <p>and Values shown for DDR SDRAM components only</p>			

(Where second W selects Industrial Operating Temperature; U selects RoHS Compliant, lead-free version.)

AC OPERATING CONDITIONS

(VDD=VDDQ=2.5V, TA= recommended operating temperature, f=1MHz)

Parameter/Condition	Symbol	Min	Max	Units	Note
Input High (Logic 1) Voltage, DQ, DQS, and DM signals	VIH(AC)	VREF+0.31		V	3
Input Low (Logic 0) Voltage, DQ, DQS, and DM signals	VIL(AC)		VREF-0.31	V	3
Input Differential Voltage, CK and /CK inputs	VID(AC)	0.7	VDDQ+0.6	V	1
Input Crossing Point Voltage, CK and /CK inputs	VIX(AC)	0.5*VDDQ-0.2	0.5*VDDQ+0.2	V	2

1. VID is the magnitude of the difference between the input level on CK and the input on /CK.
2. The value of V IX is expected to equal 0.5*V DDQ of the transmitting device and must track variations in the DC level of the same.
3. These parameters should be tested at the pin on actual components and may be checked at either the pin or the pad in simulation. The AC and DC input specifications are relation to a Vref envelope that has been bandwidth limited 20MHz.

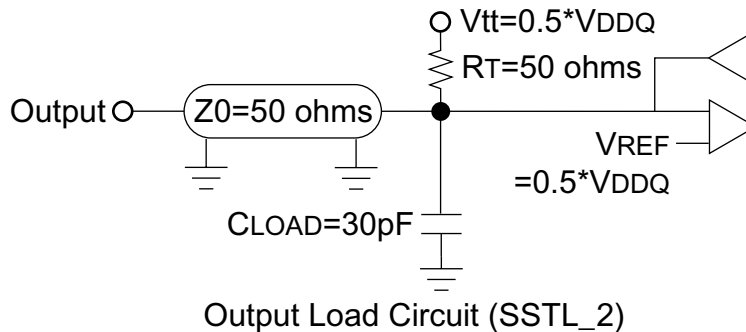

CAPACITANCE

(VDD=VDDQ=2.5V, TA=25°C, f=1MHz)

Parameter	Symbol	Max	Units
Input Capacitance : A, BA, /RAS, /CAS, /WE 30 pF adder for board.	CIN0	54	pF
Input Capacitance : CKE, /S 30 pF adder for board.	CIN1	54	pF
Input Capacitance: CK0, /CK0 15 pF adder for board.	CIN2	21	pF
Input Capacitance: CK1-2, /CK1-2 15 pF adder for board.	CIN3	24	pF
Data, DM, and DQS I/O Capacitance: DQ, CB, DQS 5 pF adder for board.	C I/O	10	pF

(Where second W selects Industrial Operating Temperature; U selects RoHS Compliant, lead-free version.)

AC TIMING PARAMETERS (These AC characteristics were tested on the component.)

Symbol	Parameter	Min	Max	Unit	Note
t _{RC}	Row cycle time	65		ns	
t _{RFC}	Refresh row cycle time	75		ns	
t _{RAS}	Row active time	45	70K	ns	
t _{RCD}	/RAS to /CAS delay	20		ns	
t _{RP}	Row precharge time	20		ns	
t _{RRD}	Row active to Row active delay	15		ns	
t _{WR}	Write recovery time	15		ns	
t _{WTR}	Internal write to read command delay	1		tCK	
t _{CK}	Clock cycle time	7.5/10	12	ns	
	Clock cycle time			ns	
	CL=2.0 (DDR266A/B)				
	CL=2.5	7.5	12	ns	
t _{CH}	Clock high level width	0.45	0.55	tCK	4
t _{CL}	Clock low level width	0.45	0.55	tCK	4
t _{DQSCK}	DQS-out access time from CK, /CK	-0.75	+0.75	ns	
t _{AC}	Output data access time from CK, /CK	-0.75	+0.75	ns	
t _{DQSQ}	Data strobe edge to output data edge		+0.5	ns	
t _{RPRE}	Read Preamble	0.9	1.1	tCK	
t _{RPST}	Read Postamble	0.4	0.6	tCK	
t _{DQSS}	CK to valid DQS-in	0.75	1.25	tCK	
t _{WPRES}	DQS-in setup time	0		ns	2
t _{WPRE}	Write Preamble	0.25		tCK	
t _{DSS}	DQS falling edge to CK rising-setup time	0.2		tCK	
t _{DSH}	DQS falling edge from CK rising-hold time	0.2		tCK	
t _{DQSH}	DQS-in high level width	0.35		tCK	
t _{DQSL}	DQS-in low level width	0.35		tCK	
t _{IS(fast)}	Address and Control Input setup time	0.9		ns	5
t _{IH(fast)}	Address and Control Input hold time	0.9		ns	5
t _{IS(slow)}	Address and Control Input setup time	1.0		ns	5
t _{IH(slow)}	Address and Control Input hold time	1.0		ns	5
t _{HZ}	Data-out high impedance time from CK,/CK	-0.75	0.75	ns	
t _{LZ}	Data-out low impedance time from CK,/CK	-0.75	0.75	ns	
t _{MRD}	Mode register set cycle time	2		tCK	
t _{DS}	DQ and DM setup time to DQS	0.5		ns	6,7,8
t _{DH}	DQ and DM hold time to DQS	0.5		ns	6,7,8
t _{DIPW}	DQ and DM input pulse width	1.75		ns	
t _{IPW}	Control and Address input pulse width for each input	2.2		ns	
t _{XSNR}	Exit self refresh to non-read command	75		ns	
t _{XSRD}	Exit self refresh to read command	200		Cycle	
t _{REFI}	Refresh interval time		7.8	μs	1
t _{QH}	Output DQS valid window	t _{HPmin} -t _{QHS}		ns	
t _{HP}	Clock half period	t _{CLmin} or t _{CHmin}		ns	
t _{QHS}	Data hold skew factor		0.75	ns	
t _{WPST}	DQS write postamble time	0.4	0.6	tCK	3
t _{RAP}	Active to autoprecharge delay	15		ns	
N/A	Data valid output window		t _{QH} - t _{DQSQ}	ns	9

Notes:

1. The refresh period is 64ms. This equates to an average refresh rate of 7.8125 μ s. However, an AUTO REFRESH command must be asserted at least once every 70.3 μ s; burst refreshing or posting by the DRAM controller greater than eight refresh cycles is not allowed.
2. The specific requirement is that DQS be valid(High or Low) on or before this CK edge. The case shown(DQS going from High_Z to logic Low) applies when no writes were previously in progress on the bus. If a previous write was in progress, DQS could be High at this time, depending on tDQSS.
3. The maximum limit for this parameter is not a device limit. The device will operate with a great value for this parameter, but system performance (bus turnaround) will degrade accordingly.
4. For registered DIMMs, tCL and tCH are \geq 45% of the period including both the half period jitter (tJIT(HP)) of the PLL and the half period jitter due to crosstalk (tJIT(crosstalk)) on the DIMM.

5. Input Setup/Hold Slew Rate Derating

Input Setup/Hold Slew Rate (V/ns)	delta tIS (ps)	delta tIH (ps)
0.5	0	0
0.4	+50	+50
0.3	+100	+100

This derating table is used to increase t IS /t IH in the case where the input slew rate is below 0.5V/ns. Input setup/hold slew rate based on the lesser of AC-AC slew rate and DC-DC slew rate.

6. I/O Setup/Hold Slew Rate Derating

I/O Setup/Hold Slew Rate (V/ns)	delta tDS (ps)	delta tDH (ps)
0.5	0	0
0.4	+75	+75
0.3	+150	+150

This derating table is used to increase t DS /t DH in the case where the I/O slew rate is below 0.5V/ns. I/O setup/hold slew rate based on the lesser of AC-AC slew rate and DC-DC slew rate.

7. I/O Setup/Hold Plateau Derating

I/O Input Level (mV)	delta tDS (ps)	delta tDH (ps)
± 280	+50	+50

This derating table is used to increase tDS/tDH in the case where the input level is flat below VREF \pm 310mV for a duration of up to 2ns.

8. I/O Delta Rise/Fall Rate(1/slew-rate) Derating

Delta Rise/Fall Rate (ns/V)	delta tDS (ps)	delta tDH (ps)
0	0	0
± 0.25	+50	+50
± 0.5	+100	+100

This derating table is used to increase tDS/tDH in the case where the DQ and DQS slew rates differ. The Delta Rise/Fall Rate is calated as 1/SlewRate1-1/SlewRate2. For example, if slew rate 1 = 5V/ns and slew rate 2 = .4V/ns then the Delta Rise/Fall Rate = -0/5ns/V. Input S/H slew rate based on larger of AC-AC delta rise/fall rate and DC-DC delta rise/fall rate.

9. The valid data window is derived by achieving other specifications: tHP (tCK/2), tDQSQ, and tQH (tQH = tHP - tQHS). The data valid window derates directly porportional with the clock duty cycle and a practical data valid window can be derived. The clock is allowed a maximum duty cycle variation of 45/55, beyond which functionality is uncertain.

REVISION HISTORY

Rev. Change Description from Previous Revision

- 101 10/01/2002. Initial release.
- 102 06/20/2005. Component based specifications added.
- 103 04/04/2006. Updated to latest format and die revs.
- 104 07/23/2007. Updated logo, web address and SPD.

DISCLAIMER OF LIABILITY

STEC™ Inc. reserves the right to make changes to specifications and product descriptions such as but not limited to numbers, parameters and other technical information contained herein without notice. Please contact the STEC™ Inc. sales office to obtain the latest specifications. STEC™ Inc. grants no warranty with respect to this datasheet, neither explicit or implied, and is not liable for direct or indirect damages. Some states do not grant the exclusion of incidental damages and as such this statement may not be valid in such states. The provisions of the datasheet do not convey to the purchaser of the device any license under any patent rights or other intellectual property rights of STEC Inc. or others.

EXPORT ADMINISTRATION REGULATIONS

The information provided may be subject to United States Export Controls. Such information should not be downloaded or exported (i), into (or to a national or resident of) Cuba, Iraq, Libya, North Korea, Iran, Syria, or any other country to which the United States has embargoed goods; or given to (ii), anyone on the United States Treasury Department's list of Specially Designated Nationals or the U.S. Commerce Department's Table of Deny Orders. By using the information, you represent and warrant that you are not located in, under the control of, or a national or resident of any such country or on any such list.

COPYRIGHT NOTICE

Copyright © 2007 by STEC™ Inc. All rights reserved. Information contained in this document, including but not limited to any instructions, descriptions and product specifications, is considered proprietary and confidential to STEC™, Inc. and shall not be modified, used, copied, reproduced or disclosed in whole or in part, in any form or by any means, electronic or mechanical, for any purpose, without the written consent of STEC™ Inc.

